

## SERIES 7500 CASEMENT WINDOW VERTICAL CROSS-SECTION FIN

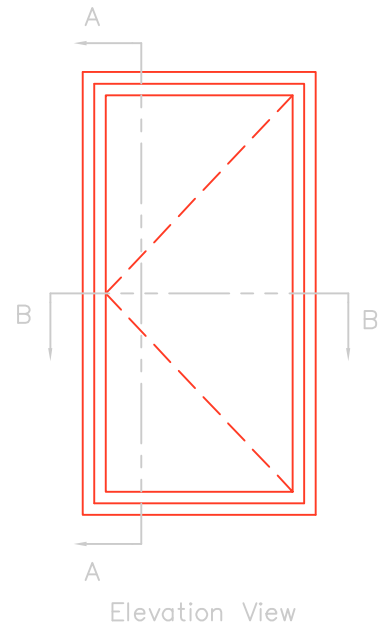

This drawing is proprietary and confidential and is intended for architectural design and/or specification purposes. It shall not be reproduced, copied, or disseminated for any other purpose without express written permission.

## SERIES 7500 CASEMENT HORIZONTAL CROSS-SECTION FIN

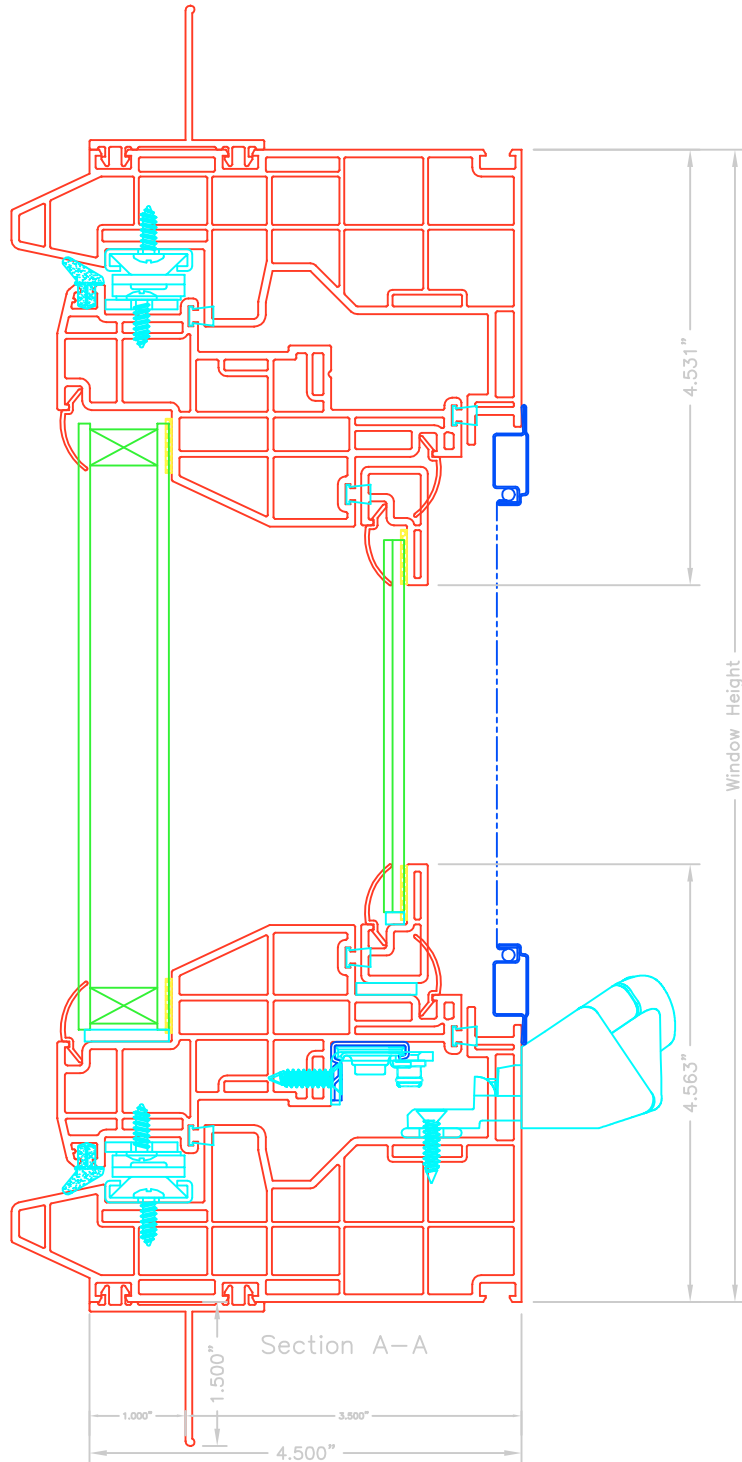
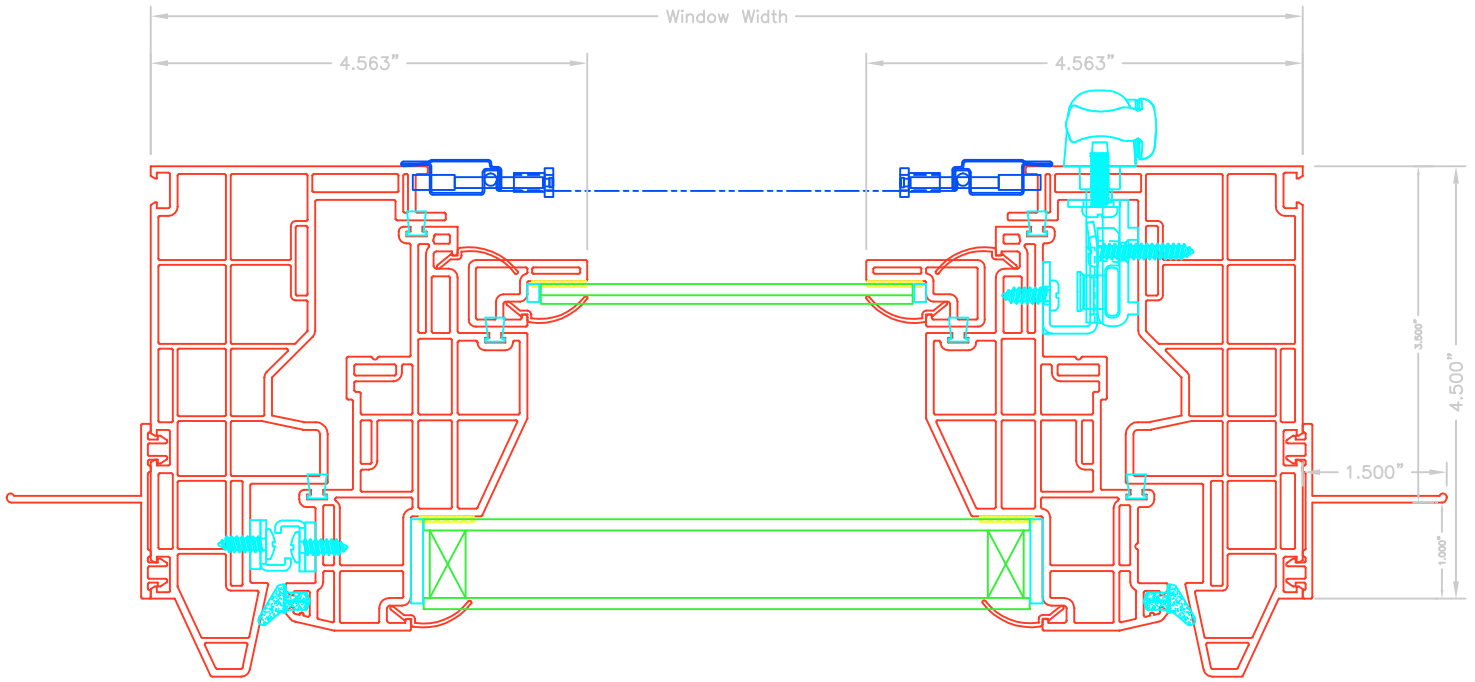

Section B-B

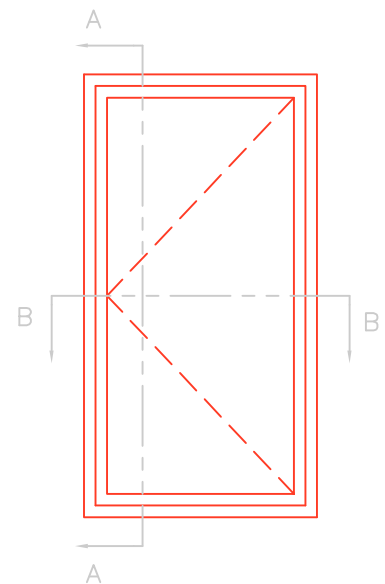

Elevation View

This drawing is proprietary and confidential and is intended for architectural design and/or specification purposes. It shall not be reproduced, copied, or disseminated for any other purpose without express written permission.

SERIES 7500 CASEMENT VERTICAL CROSS-SECTION FINLESS

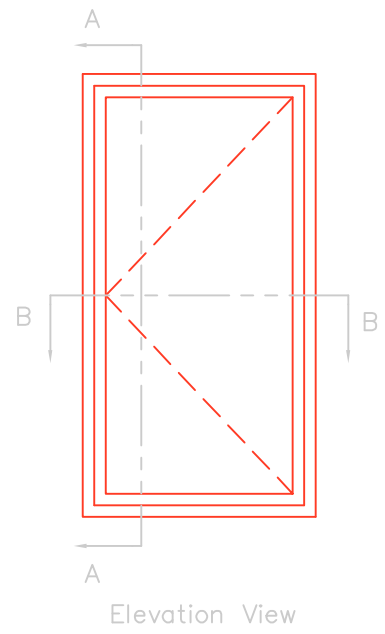
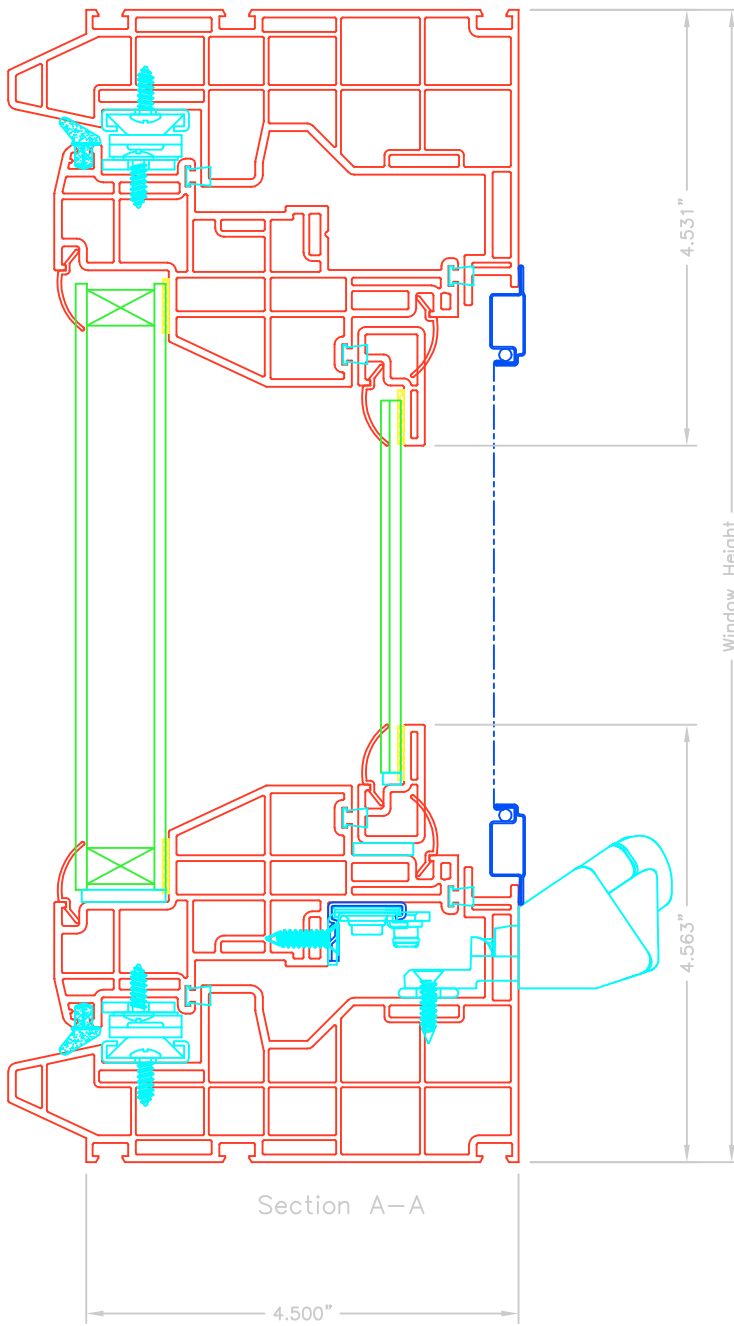

This drawing is proprietary and confidential and is intended for architectural design and/or specification purposes. It shall not be reproduced, copied, or disseminated for any other purpose without express written permission.

## SERIES 7500 CASEMENT HORIZONTAL CROSS-SECTION FINLESS

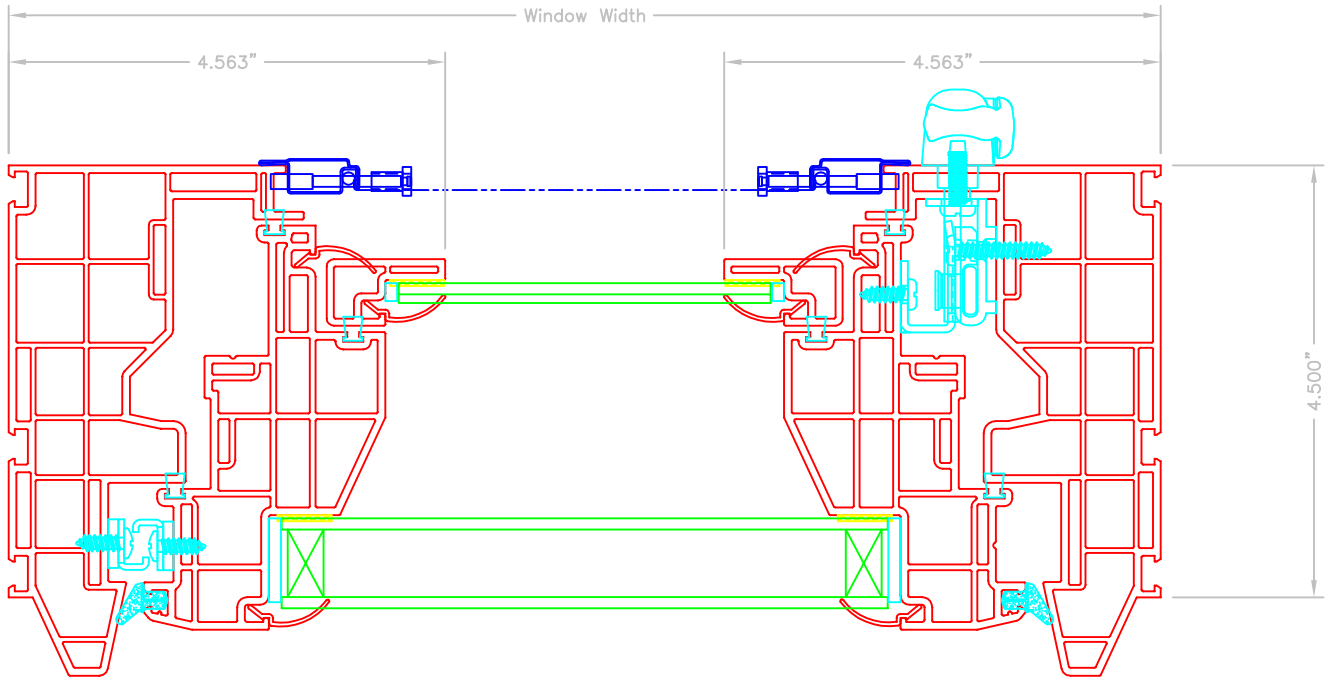

Section B-B

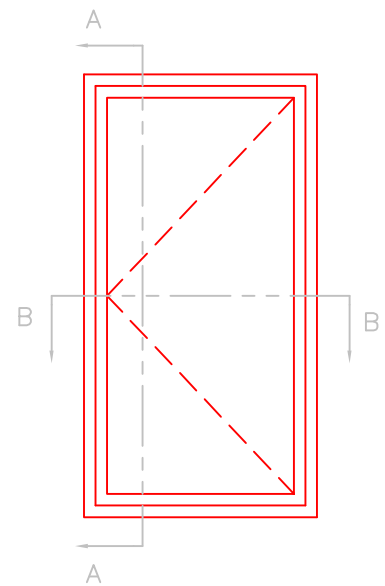

Elevation View

This drawing is proprietary and confidential and is intended for architectural design and/or specification purposes. It shall not be reproduced, copied, or disseminated for any other purpose without express written permission.