

SERIES 9000 HORIZONTAL SLIDER VERTICAL CROSS-SECTION

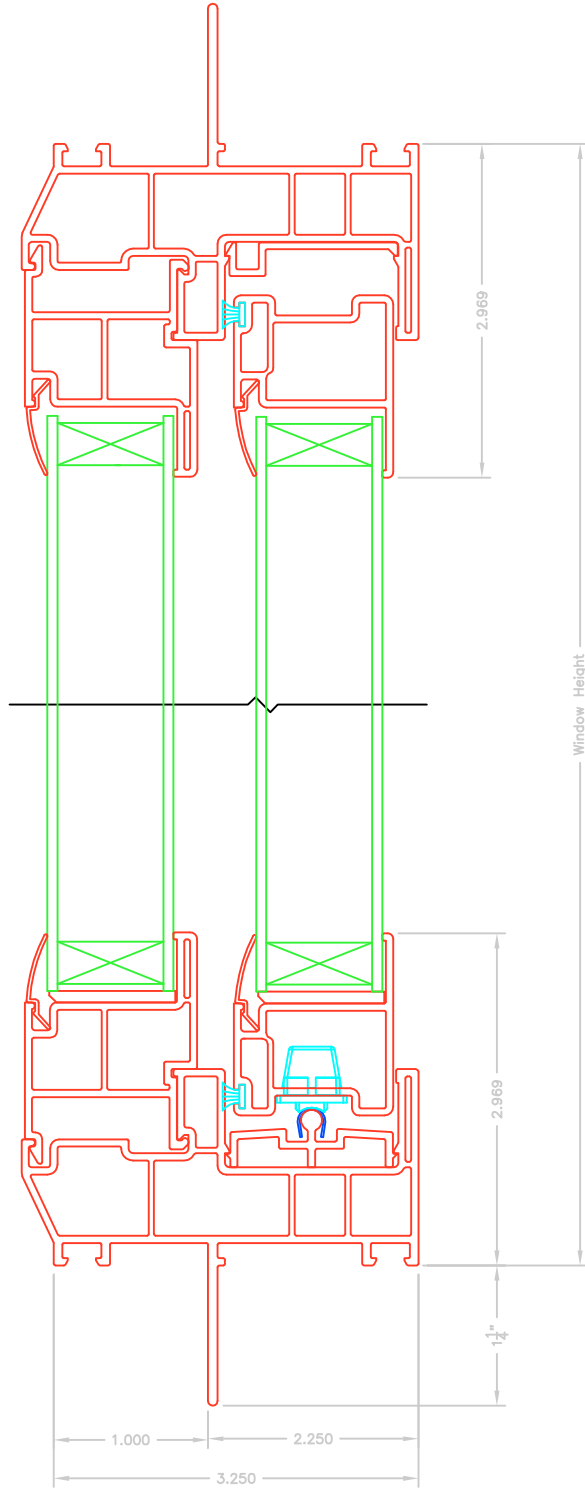

Section A-A

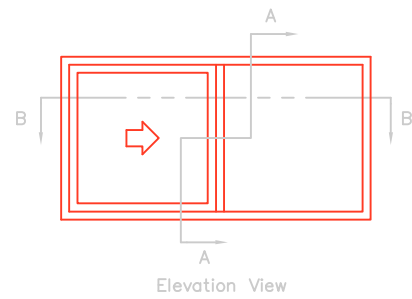

This drawing is proprietary and confidential and is intended for architectural design and/or specification purposes. It shall not be reproduced, copied, or disseminated for any other purpose without express written permission.

SERIES 9000 HORIZONTAL SLIDER HORIZONTAL CROSS-SECTION

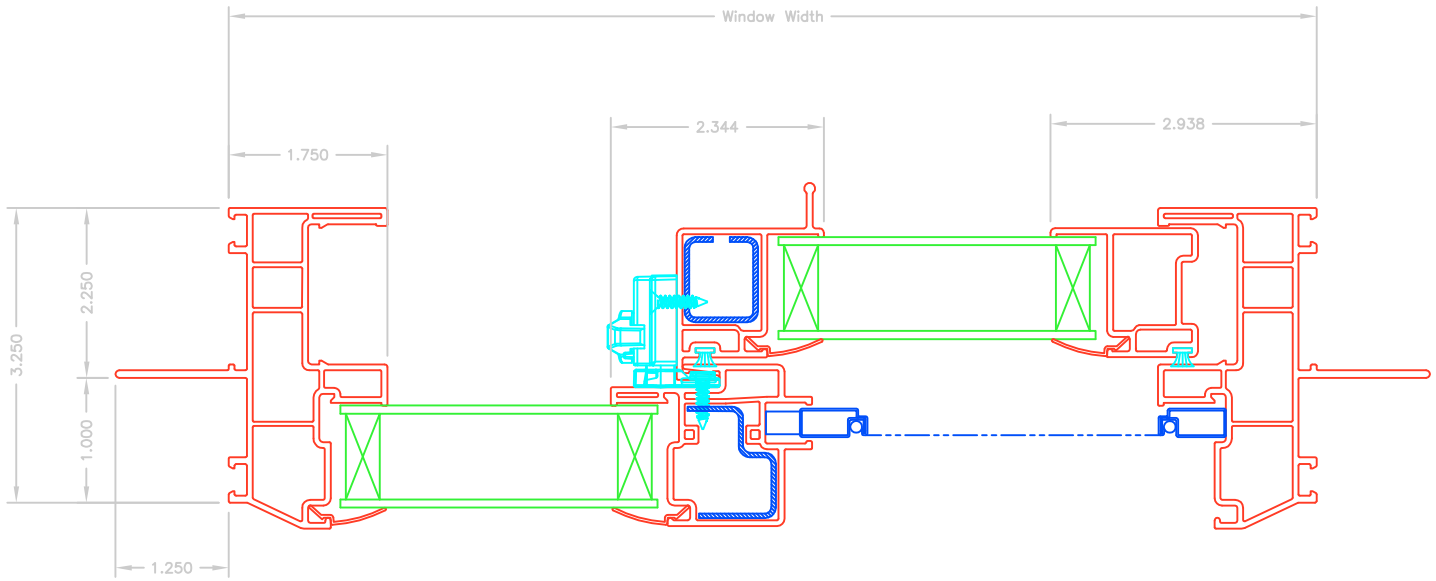

Section B-B

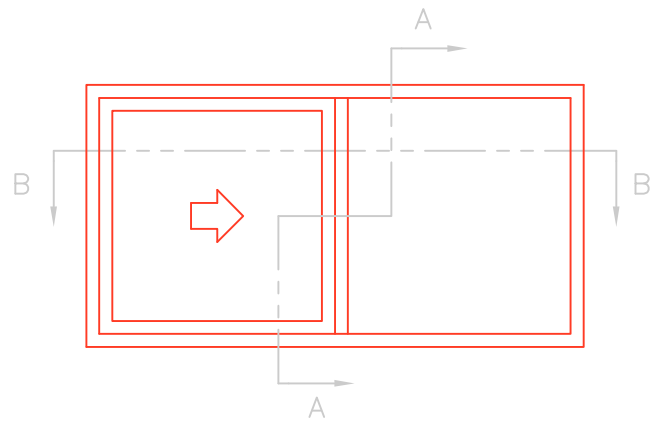

Elevation View

This drawing is proprietary and confidential and is intended for architectural design and/or specification purposes. It shall not be reproduced, copied, or disseminated for any other purpose without express written permission.

SERIES 9000 PICTURE SLIDER HORIZONTAL CROSS-SECTION

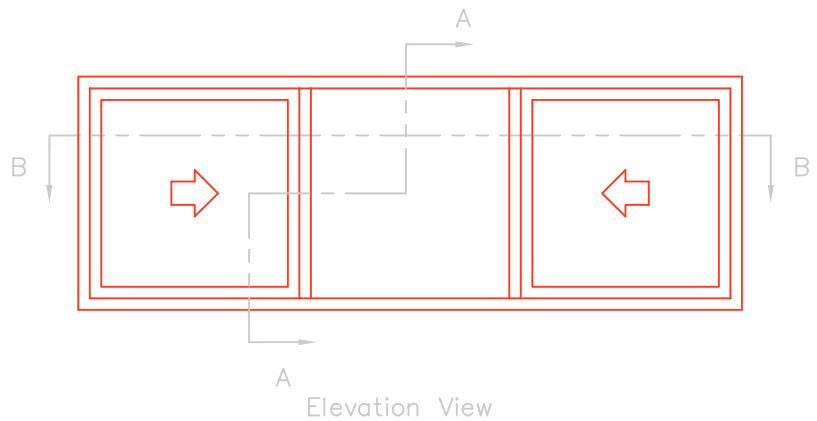
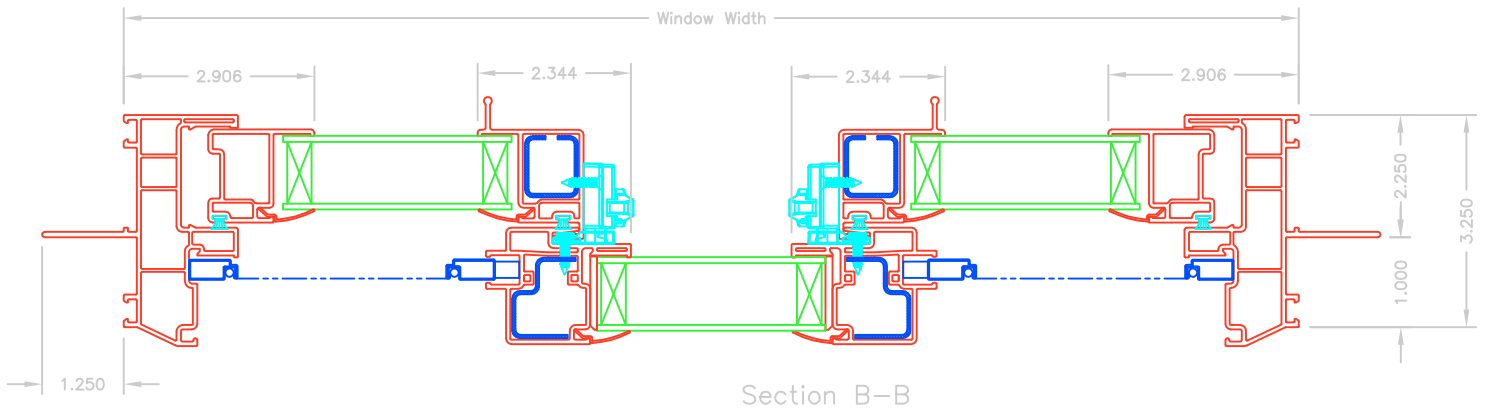

This drawing is proprietary and confidential and is intended for architectural design and/or specification purposes. It shall not be reproduced, copied, or disseminated for any other purpose without express written permission.

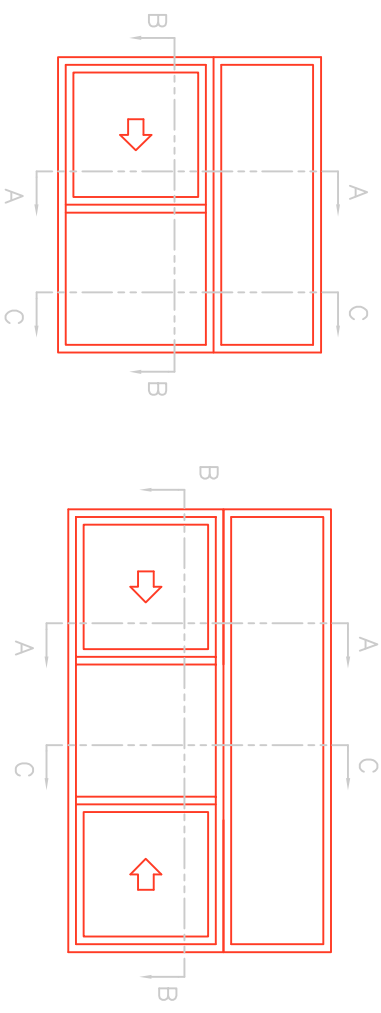
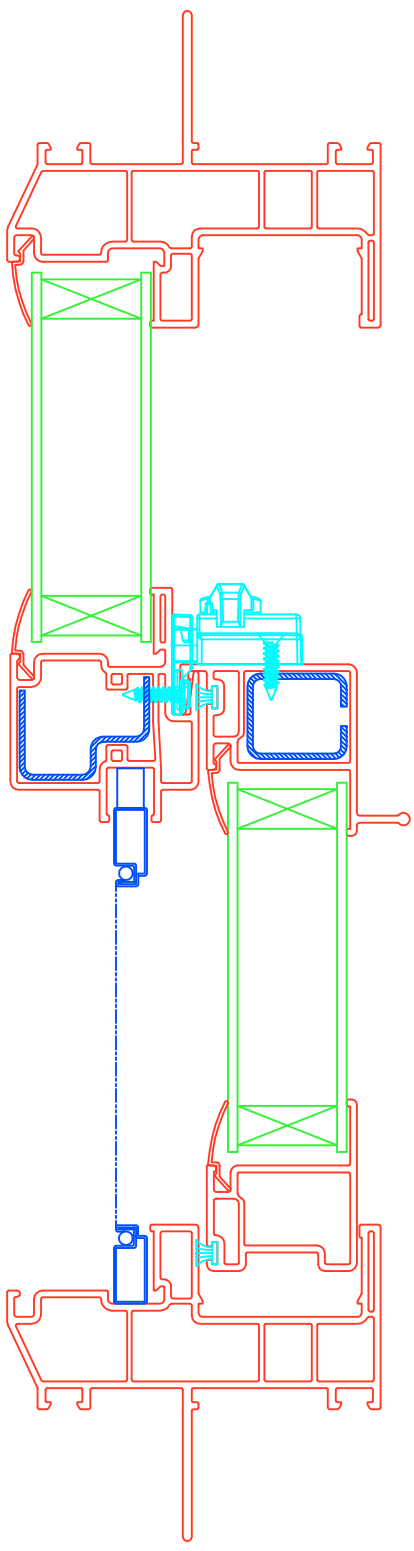
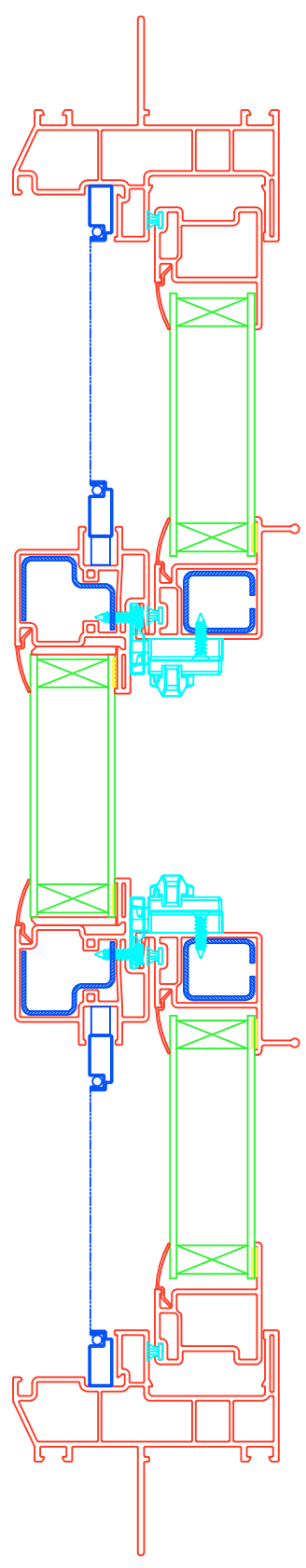
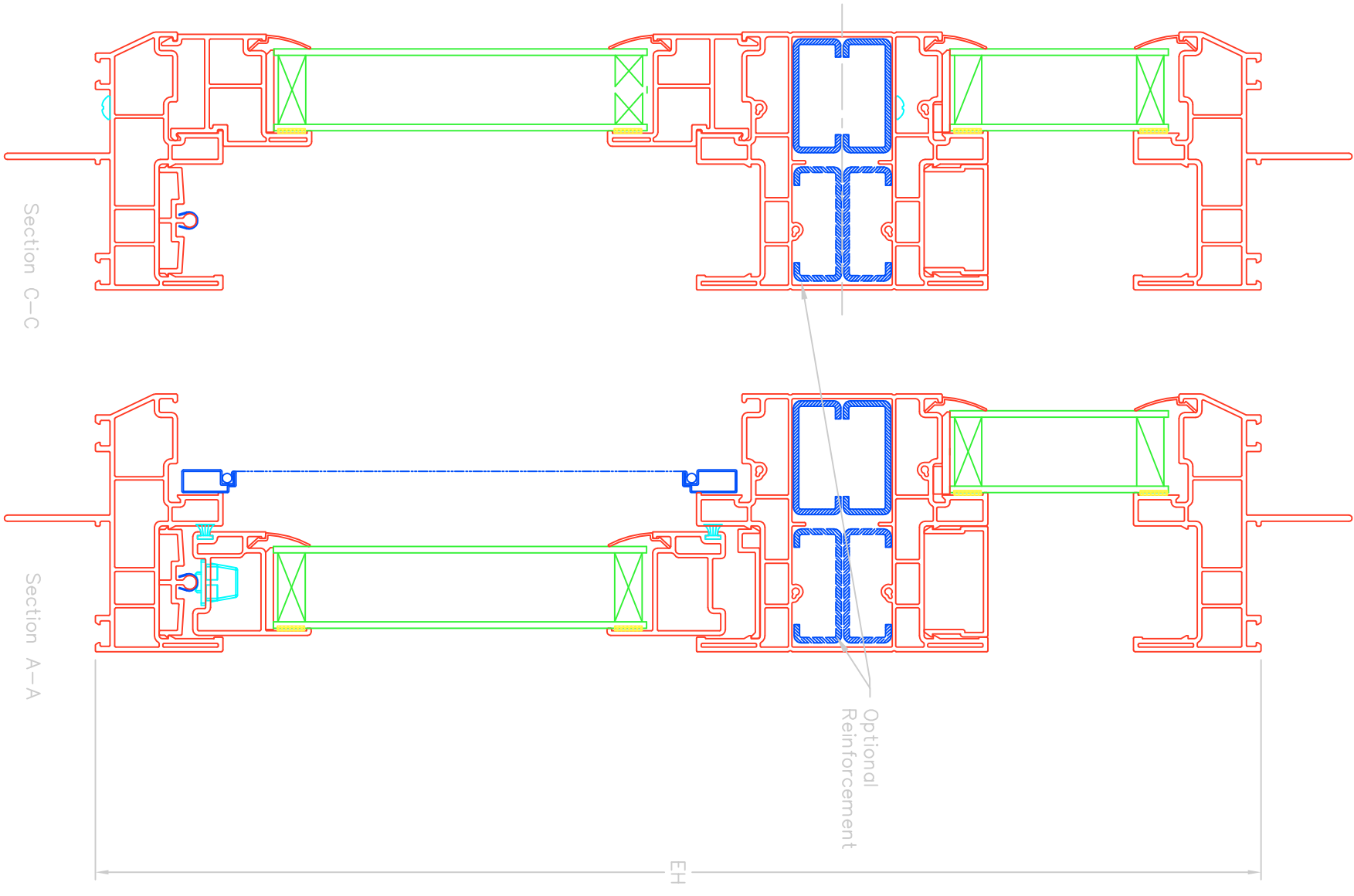

Section B-B

Section B-B

THIS DRAWING IS PROPRIETARY AND CONFIDENTIAL AND IS INTENDED FOR ARCHITECTURAL DESIGN AND SPECIFICATION PURPOSES ONLY. IT SHALL NOT BE REPRODUCED, COPIED, OR DISSEMINATED FOR ANY OTHER PURPOSE WITHOUT EXPRESS WRITTEN PERMISSION



Series 9000 Horizontal Slider Transom Stack Assembly

No.	Date	Revision Description	By	ECN #
01	07-23-2012	Updated Roller Track & Anti-lift profiles	DJC	2012-1964.12

Material (Type-Alloy-Temper):		Est. Area (in ²): NA	Tolerances: XXX = ±0.03
Drawn By: DJC		Est. Weight (lb./ft.): NA	XXX = ±0.005
Approved By: DEH		Date: 6-1-2012	XX = ±0.5
ECN# (Initial Issue): 2011-1964		File Name:	Scale: 1:2
			Sheet Size: ANSI B
			Sheet 1/3

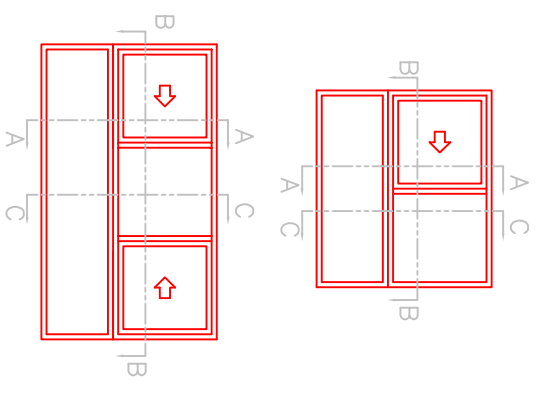
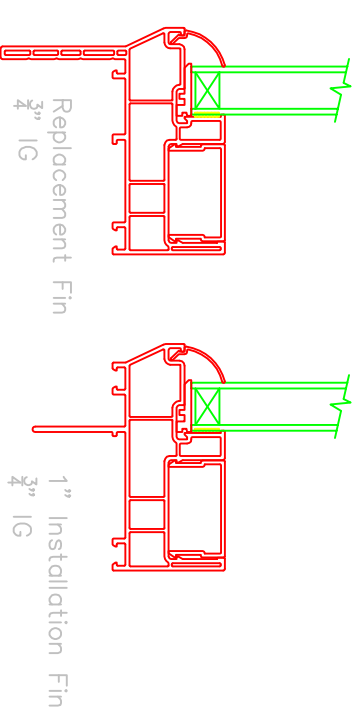
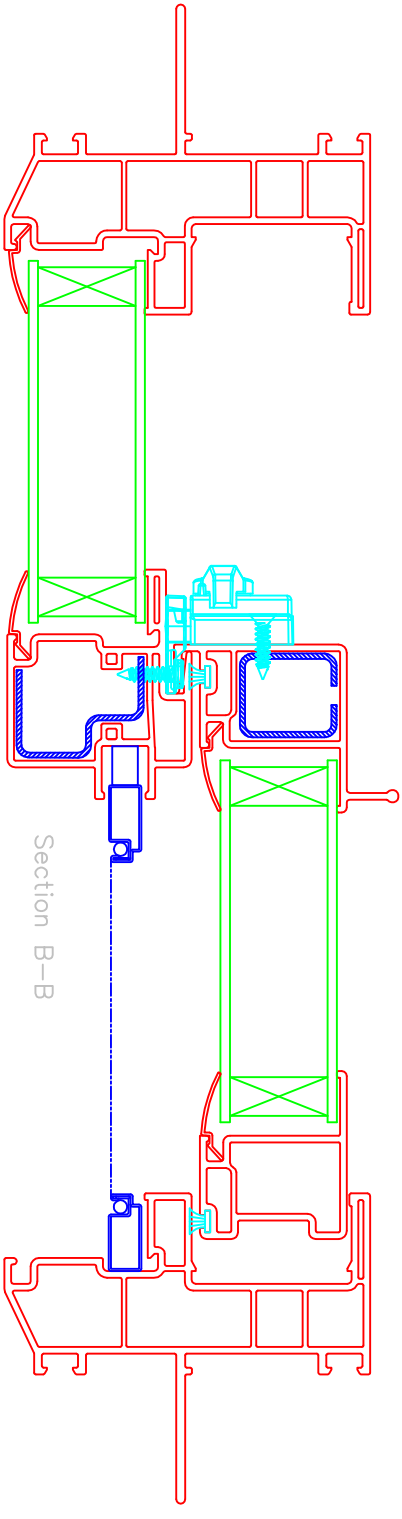
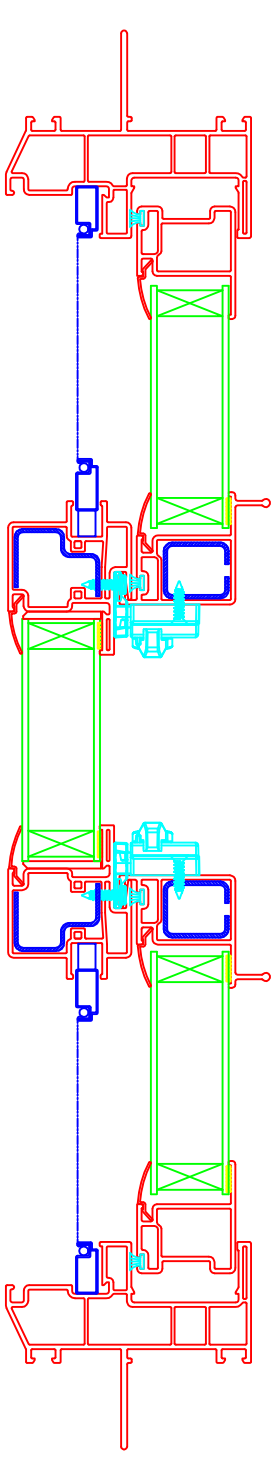
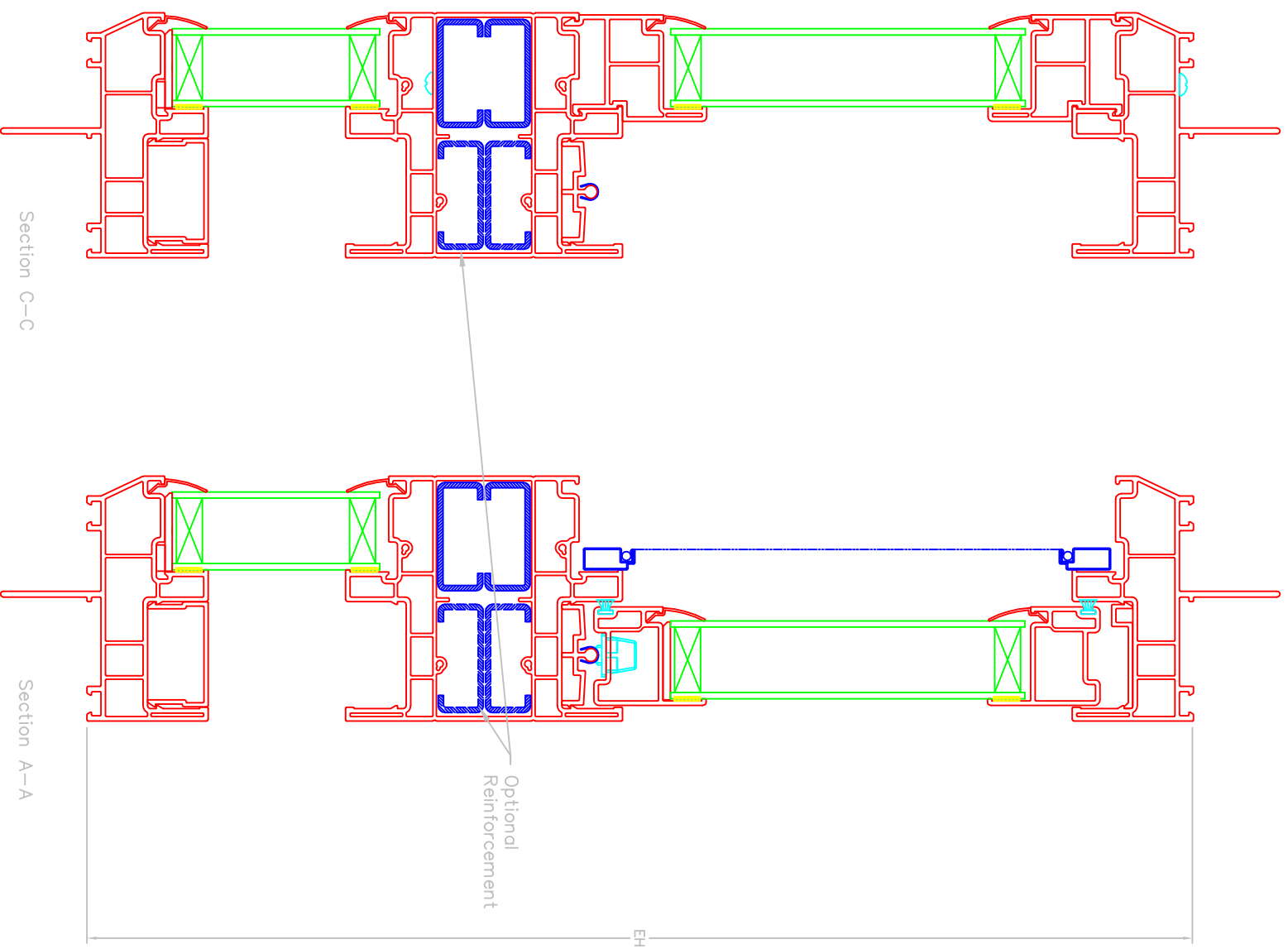

THIS DRAWING IS PROPRIETARY AND CONFIDENTIAL AND IS INTENDED FOR ARCHITECTURAL DESIGN AND SPECIFICATION PURPOSES ONLY. IT SHALL NOT BE REPRODUCED, COPIED, OR DISSEMINATED FOR ANY OTHER PURPOSE WITHOUT EXPRESS WRITTEN PERMISSION



Series 9000 Picture Window – Horizontal Slider
Reverse Stock Assembly

No.	Date	Revision Description	By	ECN #
01	07-23-2012	Updated Roller Track & Anti-lift profiles	DJC	2012-1964.12

Material (Type-Alloy-Temper):		Est. Area (in ²): NA	Tolerances: XXX = ±0.03
Drawn By: DJC		Est. Weight (lb/ft): NA	XXX = ±0.005
Approved By: DEH		Date: 6-1-2012	XX = ±0.5

ECN# (Initial Issue): 2011-1964	File Name: ADW-11 9000 HS Assembly	Scale: 1:3	Sheet Size: ANSI B
			Sheet 1/3